

OPERÆ
HOME



Teorema



TECHNICAL INFORMATION / INFORMAZIONI TECNICHE

Frame: solid fir wood, plywood, chipboard, wood fiber, covered in polyester fiber with matching fine velvet 250 gr/m²

Springing/webbing: elastic belts

Seat cushion: : gel micromax staple with polyurethane insert Density 40 kg/m³

Back cushion: polyurethane foam Density 40 kg/m³ covered in polyester fiber 200 gr/m²

Feet: beech wood wengé finish

Covers: fabric (removable covers) or leather

Pillow cushions: staple polyester microfiber in 100% Cotton Twill 271 pillowcase

Mechanism: headrest mechanism inside the back cushion

Note: optional feet in different finishing as per available samples without price surcharge, a velvet covering may require changes to cuttings and seams.

Struttura: abete massello, legno multistrato, truciolare, fibra di legno, rivestito da accoppiato in fibra di poliestere 250 gr/m²

Piano di molleggio: cinghie elastiche

Imbottitura seduta: fiocco gel micromax con inserto in poliuretano Densità 40 kg/m³

Imbottitura schienale: poliuretano Densità 40 kg/m³ rivestito da fibra di poliestere 200 gr/m²

Piedi: legno di faggio verniciato wengé

Rivestimento: tessuto(sfoderabile) o pelle

Cuscini volanti: fiocco di microfibra di poliestere in 100% Cotone Twill 271

Meccanismo: meccanismo per movimento poggia testa inserito all'interno dello schienale imbottito

Note: opzionale senza sovrapprezzo piede in diversa finitura come da campionario, un rivestimento in velluto può richiedere modifiche a tagli e cuciture.

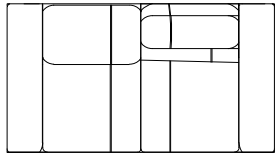
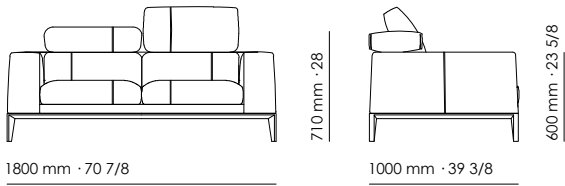

2 seater sofa
Divano 2 posti

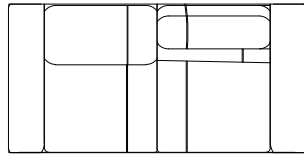
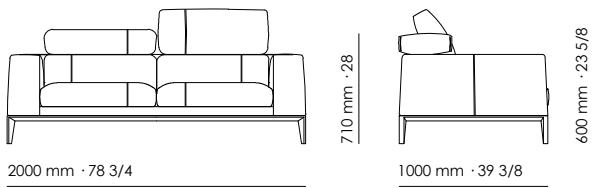

2 1/2 seater sofa
Divano 2 posti 1/2

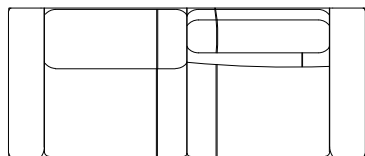
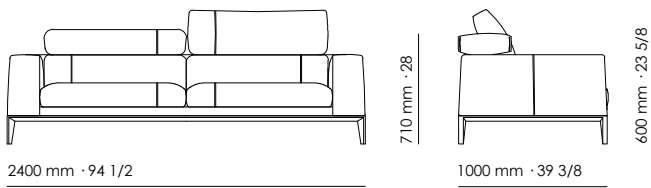

3 seater maxi sofa
Divano 3 posti grande

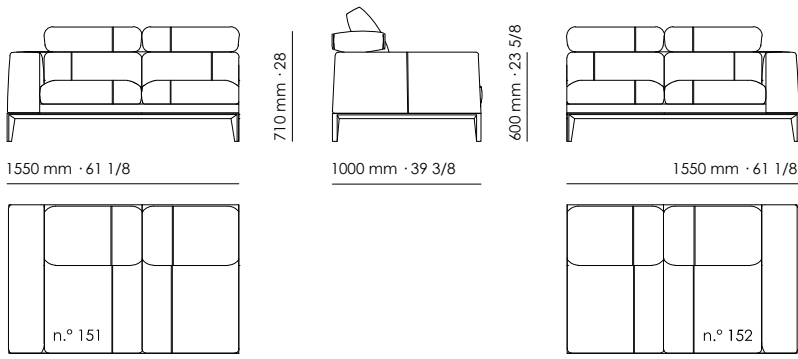

1 1/2 seater element L/R arm n.° 151/152
Elemento 1 posto 1/2 Br SX/DX n.° 151/152

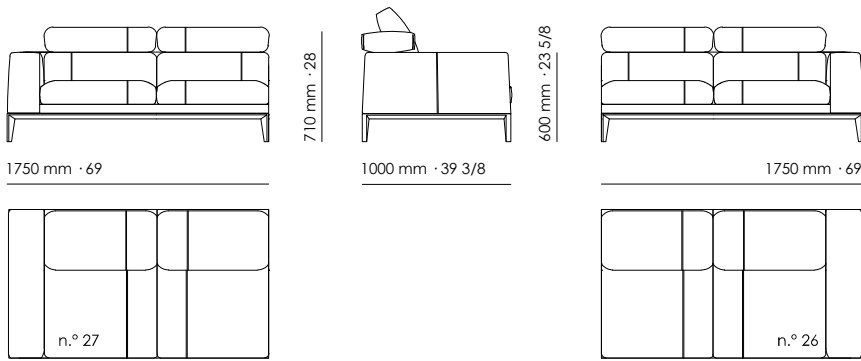

2 seater element L/R arm n.° 27/26
Elemento 2 posti Br SX/DX n.° 27/26

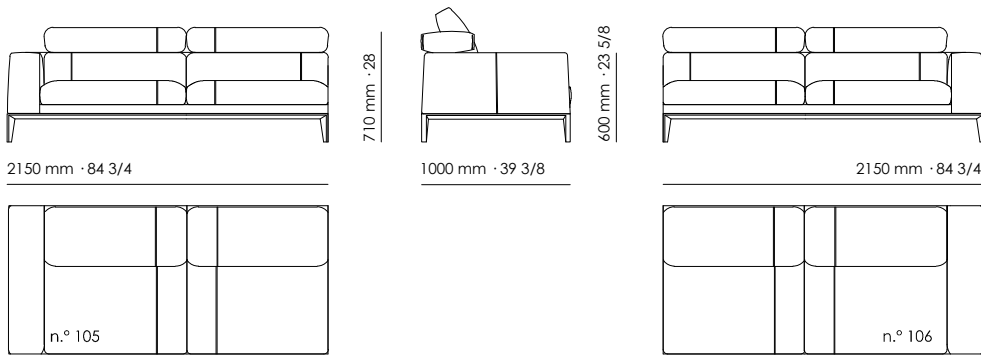

3 seater element L/R arm n.° 105/106
Elemento 3 posti Br SX/DX n.° 105/106

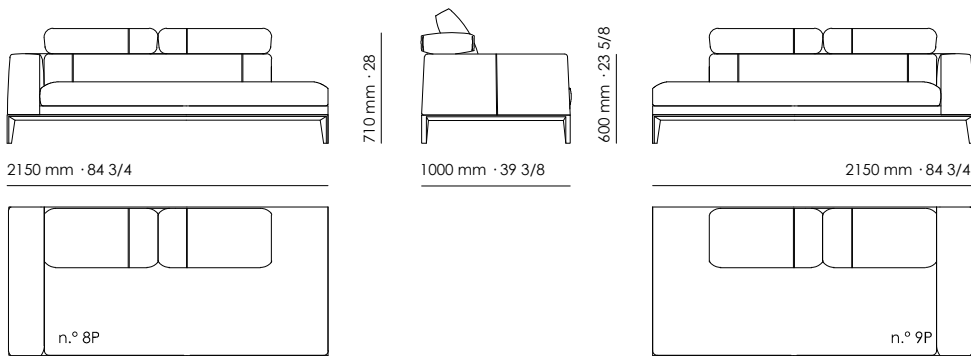

End element L/R arm n.° 8P/9P
Elemento terminale Br SX/DX n.° 8P/9P

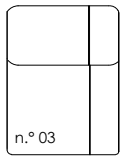
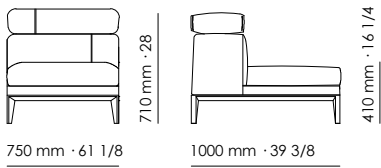

little central element n.° 03
Elemento centrale piccolo n.° 03

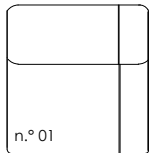
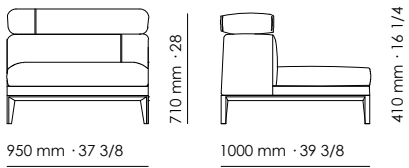

1 seater central element n.° 01
Elemento centrale 1 posto n.° 01

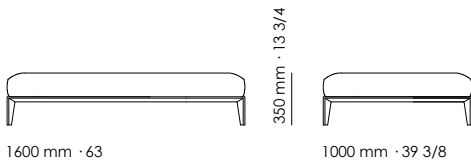

Bench pouf
Pouf panca

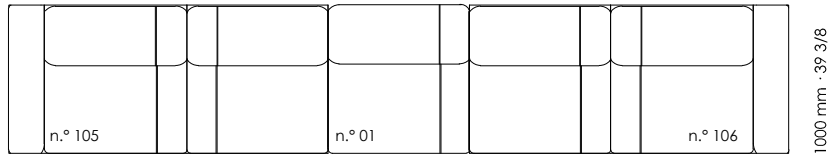
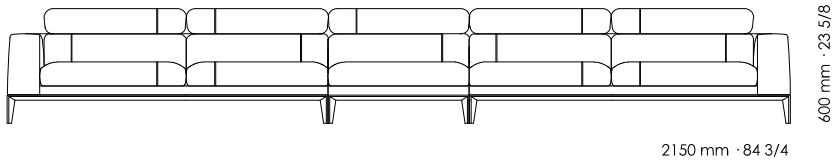

COMPO:

- #105 element
- #01 element
- #106 element

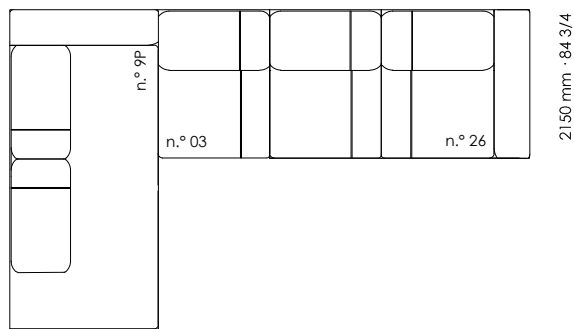
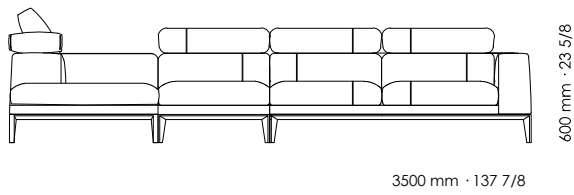

COMPO:

- #9P element
- #03 element
- #26 element

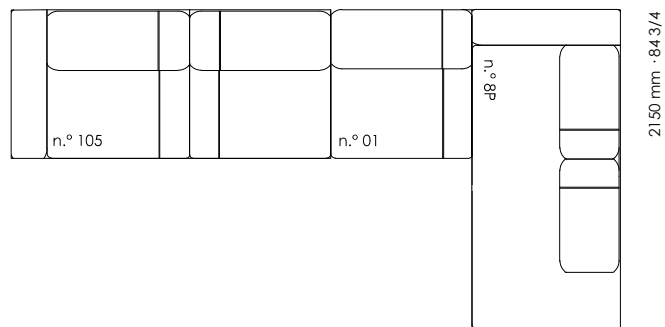
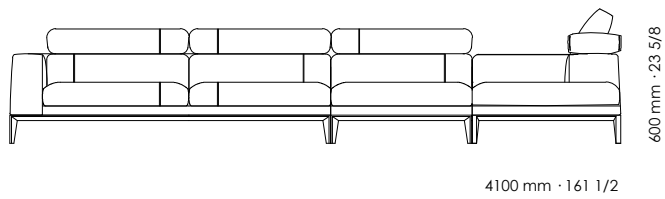

COMPO:

- #105 element
- #01 element
- #8P element

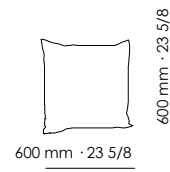
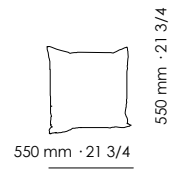
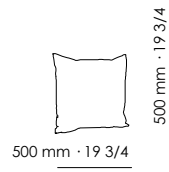
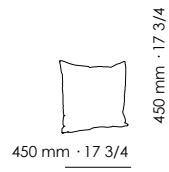
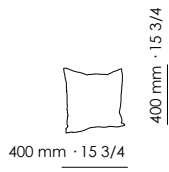

Knife edge throw pillows
Cuscini volanti a saponetta

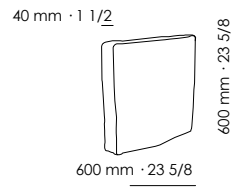
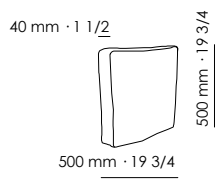
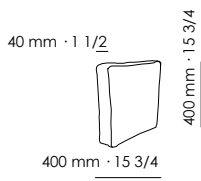

Box pillows
Cuscini con fascia

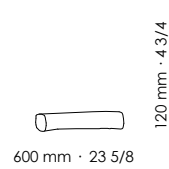
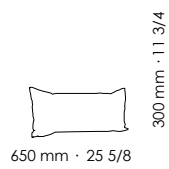
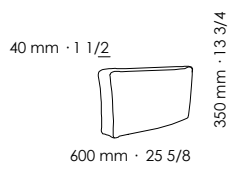
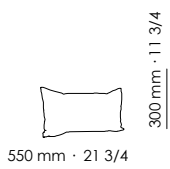

Rectangular pillows / Roll pillow
Cuscini rettangolari / Cuscino rullo